

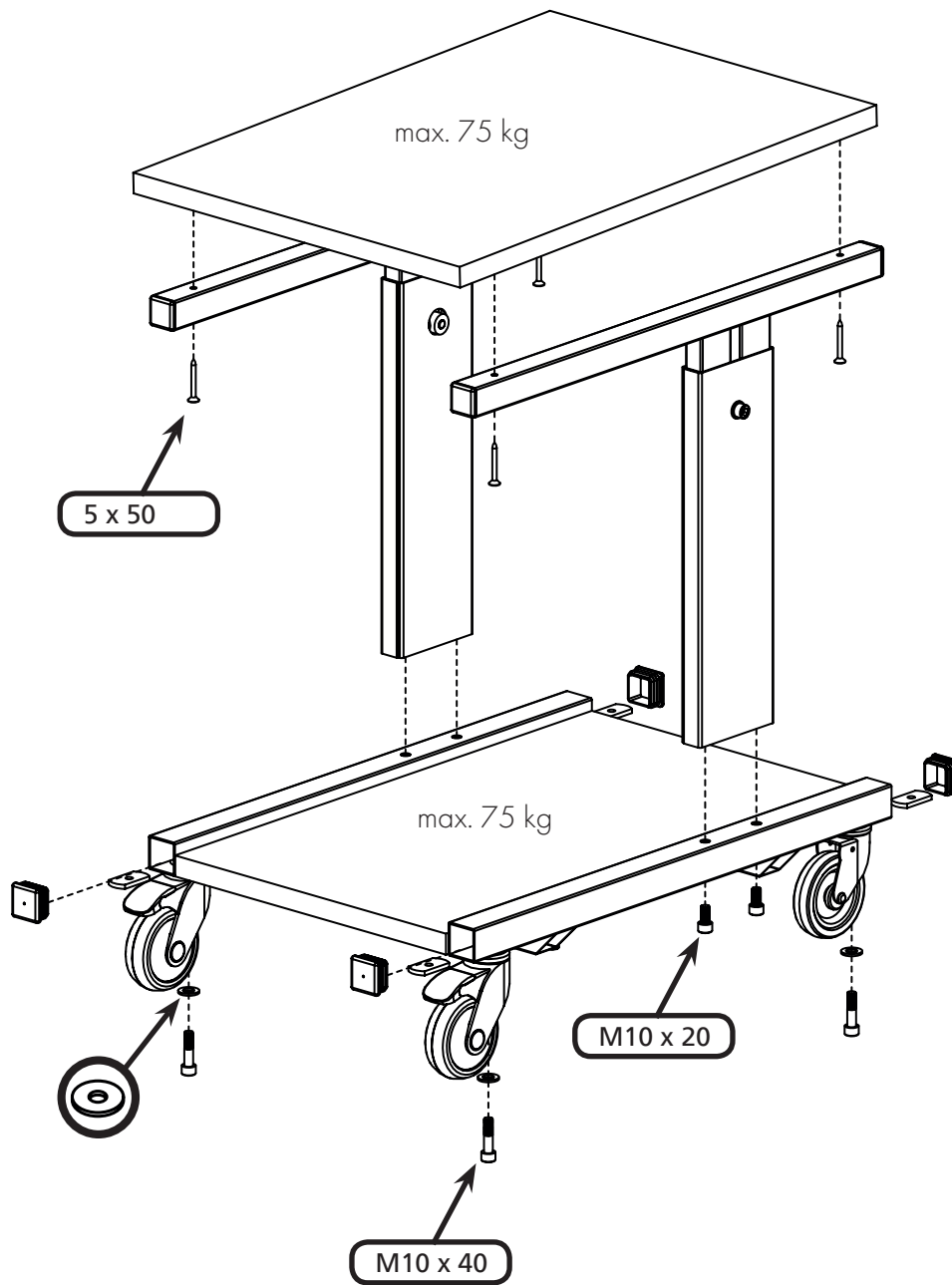

CTR

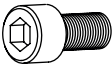
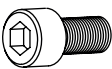
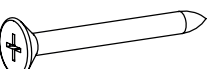
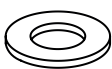

No.	Part		Pcs	No.	Part		Pcs
1		M10x20	4	4		40 x 40	4
2		M10	4	5		M10 x 40	4
3		5 x 50	4	6		ø 10	4